

Effect of high resistive barrier on earthing system

M. Osman¹, G. Chen¹ and N. Pilling²

¹University of Southampton, Southampton, United Kingdom

²National Grid plc, United Kingdom

Abstract: Substation earthing provides a low impedance path and carries current into ground under normal and fault conditions without adversely affecting continuity of service. Under a fault condition, the ground voltage may rise to a level that may endanger the public outside the vicinity of the substation. In such a case a high resistive barrier can be inserted around the vicinity of the substation to reduce the surface potentials immediately beyond the barrier. In this paper the effect of barrier on the overall performance of the earthing system has been investigated experimentally and computationally based on an earthing system consisted of combined grid and rods in a water tank. The effect of the position and depth of the barrier to the resistance of the earthing system and surface potentials in and around the substation have been examined.

1. Introduction

Power plants and substations are extremely vulnerable to hazards of lightning strikes, electrical and mechanical equipment malfunctioning, and of course, human errors in which surge current of the order of kiloamperes is impressed on the plant or is generated from within. Hence, earthing has become one of the dominant problems of system design.

Adequate earthing of electrical substations is of significant importance to increase the reliability of the supply service as it helps to provide stability of voltage conditions, preventing excessive voltage peaks during disturbances, and also providing protection against lightning. By earthing, it generally means an electrical connection to the general mass of earth, the latter being a volume of soil/rock etc., whose dimensions are very large in comparison to the electricity system being considered.

The most often quoted reasons for having an earthed system is to provide a sufficiently low impedance path and means to carry and dissipate electric currents into ground under normal and fault conditions without exceeding any operating and equipment limits or adversely affecting continuity of service. Other than that, an earthed system can assure such a degree of human safety that a person working or walking in the vicinity of grounded facilities is not exposed to the danger of a critical electric shock. Furthermore, earthing is implemented to retain system voltages within reasonable limits under fault conditions (such as lightning, switching surges or

inadvertent contact with higher voltage systems), and ensure that insulation breakdown voltages are not exceeded [1].

The purpose of this research is to increase the safety level outside the vicinity of the substation while not neglecting the safety of the personnel inside the substation. In order to achieve this, one of the methods investigated here is using a highly resistive barrier. When the barrier is buried at a certain depth and distance from the earthing grid, it can reduce the surface potentials immediately beyond the barrier. However, this has to be compensated with a slight increase in the resistance of the earthing system. This is due to the current path being interrupted.

2. Electrolytic Tank

The need for accurate design procedures for the earthing system becomes more important both from a safety point of view and from financial considerations, as the number and complexity of AC substations increase. When all the physical dimensions of a grounding grid system are reduced in size by the same scale factor (this includes the conductor diameter and the depth to which the grid is buried), the pattern of current flow and the shape of the equipotential surfaces are unaltered. Some further changes are necessary in order for modeling to be of practical value. The full-scale grid is buried in semi-infinite earth, but a solid medium is inconvenient both from the measurement standpoint and when delicate model grids must be frequently removed for modifications and replaced. Hence, the obvious alternative is an electrolytic tank. The electrolyte presents no particular problem for the homogeneous case as water is a convenient choice.

In essence there are only three methods for evaluating the performance of a grounding grid. These are the measurements on a full-scale grid, numerical computation, and measurement on a scale model grid. Full-scale tests are both costly and difficult to perform, hence they are very unattractive. Numerical methods, on the other hand, are very convenient to use once the necessary programs are available and thoroughly verified. Creation of these programs, however, is not without its problem. In all but the simplest cases, it is necessary to make some simplifying assumptions.

Scale modelling provides a valuable alternative method. It requires only a very modest investment in

equipment. It can be used to verify numerical methods during the development phase. Once an electrolytic tank has been set up, it is possible to make changes on grid models quickly and easily.

3. Experimental Arrangement

The experimental tank used in this research is cylindrical and measures 2m in diameter and 1.2 m depth. It also has a plastic liner that covers the inner part of the tank. The model earthing mat is mounted on a central platform suspended from a rigid arm attached to one of the vertical steel wall struts. The potential on the surface of the water is measured by a probe suspended by a plumb-bob arrangement from a horizontal arm that is free to rotate about the axis of the tank through 360°. Only the tip of the wire is touching the surface of the water. Surface potential measurements within the platform area are obtained by inserting fixed probes through 1.5mm holes in the platform. The platform is made from hard clear Perspex that will not absorb water and it provides a horizontal configuration with the minimum distortion and sag.

The true earth plane is a flat zinc-coated steel mesh, containing very small holes, whose height from the tank bottom can be adjusted. The resistance of a single vertical rod was measured with the mesh between 0.8m and 1.1m below the surface. No significant difference was found and so the earth plane is sufficiently distant at 1.0m. The inner circular side of the tank is also conducting; it is covered using the same material as the flat mesh.

It was originally intended to dope the water in order to lower the measured resistance (so that a low voltage supply can be used), but the conductivity of Southampton tap water is in the region of 0.055 Sm⁻¹ which is quite satisfactory. The conductivity is measured every time the tank is used with a conductivity meter, which is calibrated each time before every experiment.

The model rods are made of brass and are 1.56 mm in diameter and 60 mm in length. The grid configuration used in this barrier experiment is the combined vertical and horizontal rod, which is 240mm x 240mm in size and each intersection of the mesh has a vertical rod. Figure 1 below illustrates the earthing grid used.

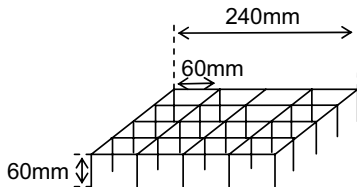

Figure 1: Combined grid configuration

Other equipment involved is a low voltage ac power supply for supplying voltage and a digital multimeter, for measuring either current or voltage. A variable resistor was used between the conducting tank lining and one side of the power supply to simulate approximately the resistance between the outer tank wall and infinity. This variable resistor is calculated by assuming that the equipotentials have now become hemispheres for radius of tank, $r > b$, where b is the hemispherical radius representing the cylindrical tank. In this region $V(r)$ obeys Laplaces equation with solution

$$V = K_1 r^{-1} + K_2$$

As $r \rightarrow \infty, V \rightarrow 0$ so that $K_2 = 0$. Also, if the current I crosses $r=b$ with **uniform density**, we have

Now

So that

$$J_r = \frac{I}{2\pi b^2} = \sigma E_r = -\sigma \frac{\partial V}{\partial r} \Big|_{r=b}$$

And

$$\frac{\partial V}{\partial r} = -K_1 r^{-2}$$

At $r=b$,

$$\frac{\partial V}{\partial r} \Big|_{r=b} = -K_1 b^{-2}$$

$$\sigma K_1 b^{-2} = \frac{I}{2\pi b^2}$$

$$\therefore K_1 = \frac{I}{2\pi \sigma}$$

$$\therefore V = \frac{I}{2\pi \sigma} r^{-1}$$

This is consistent with taking the resistance of a

$$\therefore V_b = \frac{I}{2\pi \sigma b}$$

hemispherical electrode of radius b [2,3], and hence equation (1) gives the value of the external resistor is

$$\therefore R_e = \frac{1}{2\pi \sigma b} \quad (1)$$

The applied voltage thus simulated that which would exist between the earthing electrode being tested and infinity. A high impedance voltmeter was used to monitor this voltage and the digital multimeter measures the current through the tank and external resistor. The ratio of these two readings is a measure of the effective grid resistance when buried in a semi-infinite earth. The multimeter also measures the potential of the voltage probe with respect to "infinity". Figure 2 illustrates the electrolytic tank circuit.

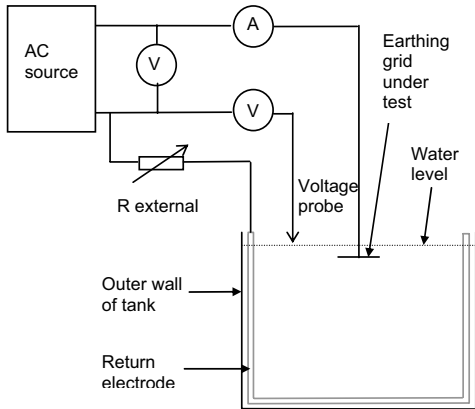

Figure 2: electrolytic tank circuit

With a working system developed, the next objective was to establish the validity of the results obtained. Several approaches were taken to this. The bottom earth plane was made in such a way that it could move up and down, hence altering the depth of the tank. By measuring the same model grid in various tank depths, it was possible to establish that the finite size of the tank did not prevent correct potential profiles being measured. As a second check, comparisons were made between measured results and those obtained by numerical computation in the limited number of cases when computed values were obtainable from outside sources.

4. Barrier Dimensions and Arrangements

The barrier used in the experiment is a solid rectangular barrier made of Teflon (insulating material). The barrier dimension is 650mm x 400mm x 9.8mm. In the experiment done, the length of the insulating barrier running parallel to one side of the electrode array was 650mm and the distance between the inner surface of the barrier and the edge of the array was varied between 60mm and 240mm in steps of 60mm. The depth of the barrier below the surface of the water ranged from 60mm and 240mm in steps of 60mm, having been arranged to be lowered on two supporting wires in increments of 60mm. Figure 3 and Figure 4 illustrate the side and top view of the system under examination (drawn not to scale).

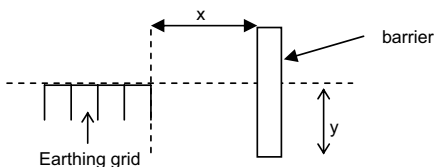

Figure 3: Side view of barrier system

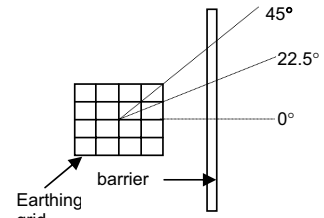

Figure 4: Top view of barrier system.

5. Results of Computation and Experimentation

A computer program called CDEGS MALT [4] is also used to model the barrier system. The computation results are used to compare with the experimentation results. The measured curves of resistance against barrier depth for CDEGS and experimental results are shown in Figures 5 and 6 respectively, together with the line indicating the original resistance before the barrier was lowered. The difference between the experimental and CDEGS results are well within experimental error, i.e. less than 1% difference.

The resistance rises due to the fact that the length of the current path on one side of the array is increased by the presence of the barrier, but even in the worst case shown (a deep barrier close to the array) the increase is between 10.3% and 11.9% for both cases (CDEGS and experimental results). Typically for a sensible barrier depth and spacing in the region of two vertical rod lengths, we have an increase of less than 4%.

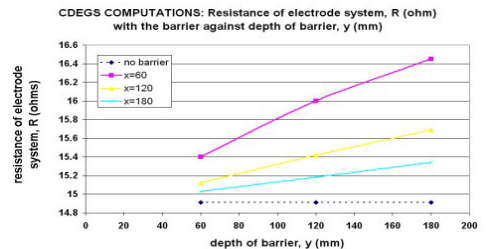

Figure 5: CDEGS Resistance of earthing system, R (ohms) against depth of barrier, y(mm)

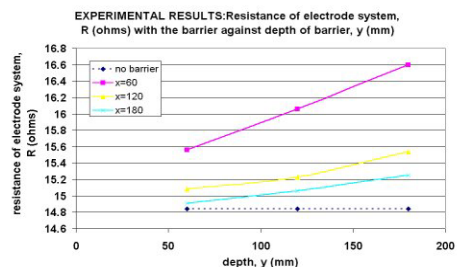

Figure 6: Experiment Resistance of earthing system, R (ohms) against depth of barrier, y(mm)

The surface potential distribution was measured along radii at angles of 0° (perpendicular to the edge of the array and through the centre of the barrier), 22.5° and 45° . Being an insulator, it was only necessary to have a thin barrier of 9.8mm thickness.

Figures 7 to 9 show the potential distributions of the barrier earthing system. Not all of the results are shown in the graphs here. These three graphs show the comparison between CDEGS and experimental results for barrier position $x=180\text{mm}$ and varying y for 0° traverse. For all the different configurations of barrier position, the results obtained from the experiments are lower than the computed results by less than 1% outside the barrier, and about 6-10% for some of the measurements near the grid (between the barrier and the grid). This is within experimental error.

As expected, the results obtained here show that in the presence of a high resistivity barrier, the surface potential between the earthing grid and the barrier increases, whilst that outside the barrier decreases, compared to the values in the absence of a barrier. The latter must have a depth of at least two vertical rod lengths before the external reduction is significant, especially close to the back of the barrier for all the three measured angles.

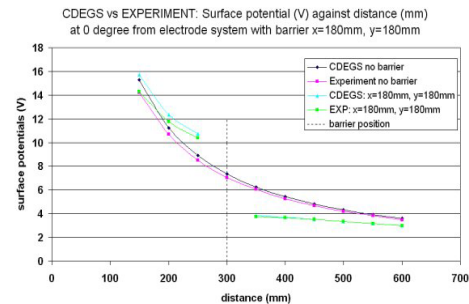

Figure 7: CDEGS vs Experiment-Surface potential against distance at 0° from electrode system with barrier $x=120\text{mm}$, $y=60\text{mm}$

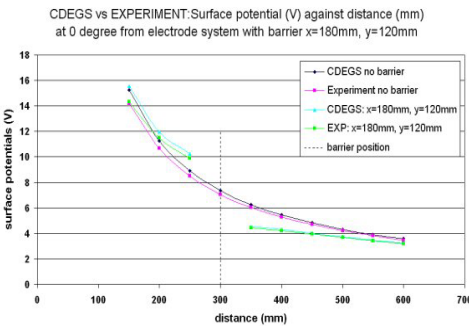

Figure 8: CDEGS vs Experiment-Surface potential against distance at 0° from electrode system with barrier $x=120\text{mm}$, $y=120\text{mm}$

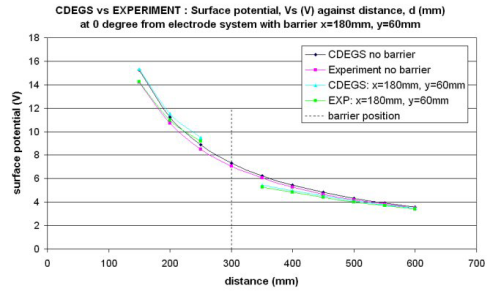

Figure 9: CDEGS vs Experiment-Surface potential against distance at 0° from electrode system with barrier $x=120\text{mm}$, $y=180\text{mm}$

6. Conclusions

A study of the influence of a highly resistive barrier to an earthing system has been carried out. An electrolytic tank and a grid consisting of horizontal and vertical rods have been used. The study verifies that with a highly resistive barrier present, the resistance of the earthing system will increase and the surface potentials will decrease at positions beyond the barrier. Factors such as the position and depth of the barrier have been examined. It has been found that for a sensible barrier depth and spacing in the region of two vertical rod lengths, there is an increase of less than 4% in the resistance of the earthing system, compared to when no barrier is present. As for the surface potentials, at barrier depth and spacing of two vertical rod lengths, a decrease of up to about 35% in surface potentials can be achieved. Hence, lower step potentials can be obtained beyond where the barrier is positioned.

7. Acknowledgements

The authors wish to thank National Grid plc and Electrical Power Engineering Group (University of Southampton) for the financial support and facilities provided during this research effort.

8. References

- [1] T. Charlton, *Earthing Practice*, Copper Development Association, February 1997.
- [2] G. F. Tagg, *Earth Resistances*, George Newnes Limited London, 1964.
- [3] *A Guide for Assessing the Rise of Earth Potential at Substation Sites*, EA Engineering Recommendations S34, Electricity Association Services Ltd., 1986.
- [4] *CDEGS Manual Book*, Safe Engineering Services & Technologies Ltd., 154 Viel, Montreal, Quebec, Canada, H3M 1G4, 1999.

Author address: Dr. George Chen
 Tony Davies High Voltage Laboratory, University of Southampton, United Kingdom
 Email:gc@ecs.soton.ac.uk